

CM 82S4

Gru idraulica a montaggio rapido

Hydraulic crane with quick assembling
Grue hydraulique à montage rapide
Hydraulischer Schnellmontagekran
Grúa hidráulica de montaje rápido

serie performance

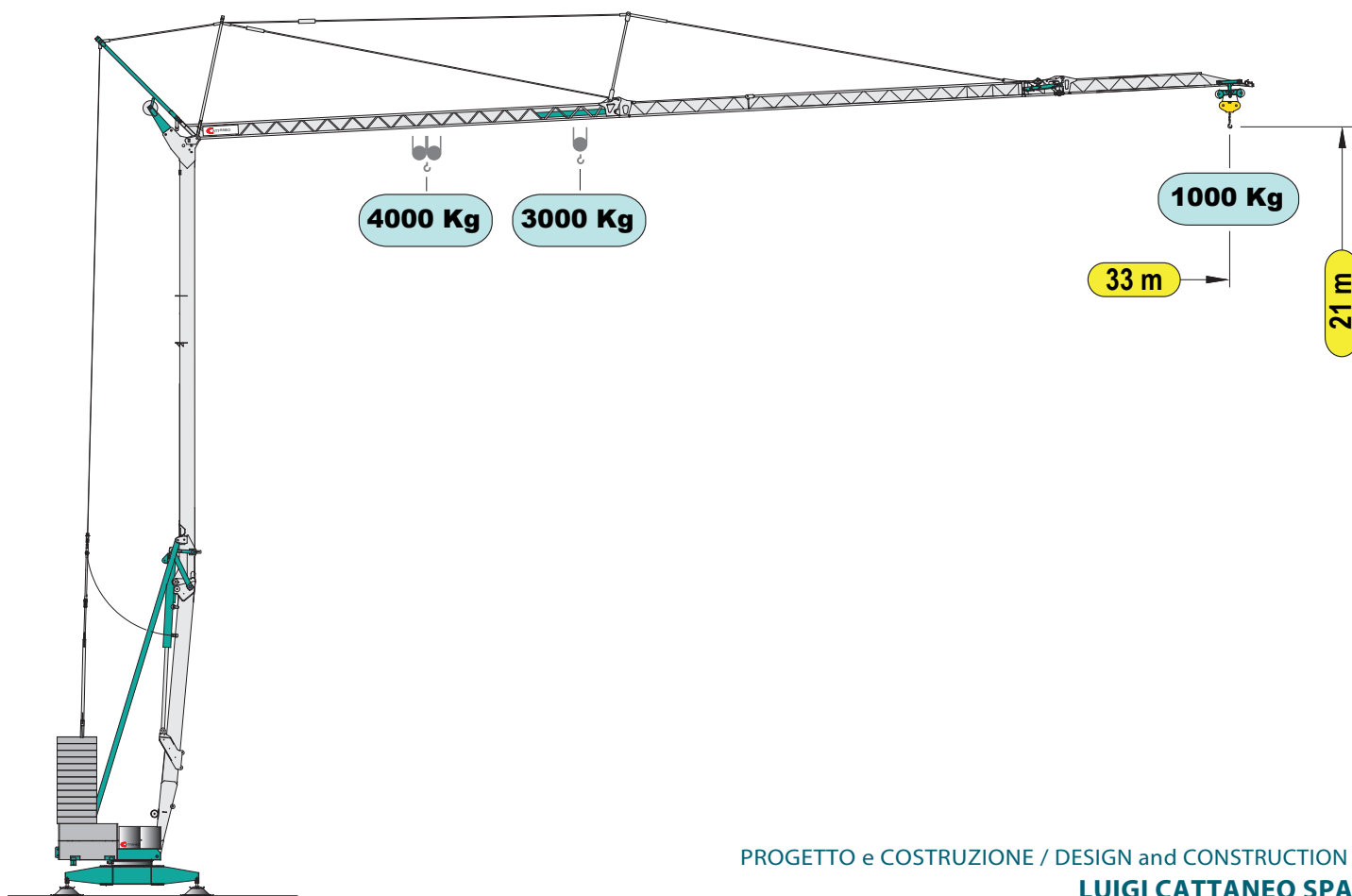

PROGETTO e COSTRUZIONE / DESIGN and CONSTRUCTION :
LUIGI CATTANEO SPA

La LUIGI CATTANEO S.p.A. ringrazia le proprie maestranze, i tecnici progettisti, i responsabili della produzione, i fornitori e tutti coloro che hanno collaborato con entusiasmo alla realizzazione di questo ambizioso progetto. Un ringraziamento va anche ai clienti che ci dimostrano la loro fiducia e ai collaboratori che si impegnano a far conoscere questa macchina sul mercato.

www.cattaneogru.it

CATTANEO





EN 14439 C25

DIN 15018-H1/B3



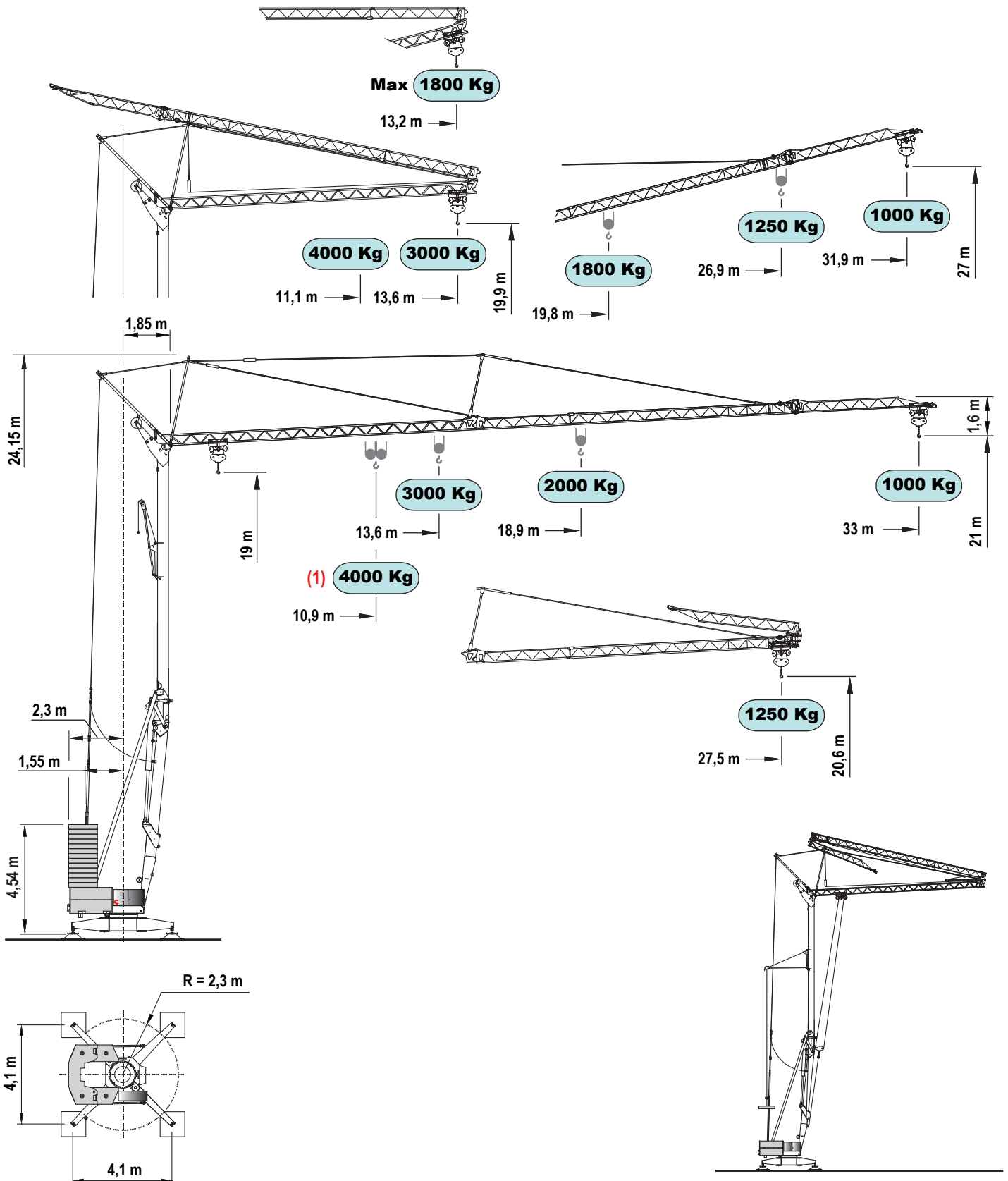





CM 82S4

 Nessun componente elettrico sul braccio e sulle parti alte della gru
No electrical component on the jib and the top of the crane

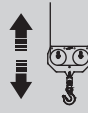

																
Curve di carico	kg	4000	3500	3000	2500	2000	1900	1800	1700	1600	1500	1400	1300	1250	1100	1000
Load diagrams	m	10.9	12.1	13.7	15.8	18.9	19.7	20.6	21.5	22.6	23.9	25.2	26.9	27.5	30.6	33.0
Courbes de charge	m	11.1	12.3	13.9	16.0	19.1	19.9	20.8	21.7	22.8	24.1	25.4	27.0	27.5		
Lastkurven	m															
Curvas deargas	m							19.8	20.9	21.9	23.1	24.4	25.9	26.9	29.6	31.9

Prestazioni - Performances - Prestations - Leistungen - Prestaciones

	 kW	 400V - 50Hz 16 kW					
	inverter	kW/g/min		1°	2°	3°	4°
				m/min	4	20	35
	inverter (1)	kW/g/min		2	10	17,5	25
				kg	3000	3000	2000
	inverter	3/1400	m/min 25 - 50				
	inverter	3,7/900	g/min 0,3 - 0,9				

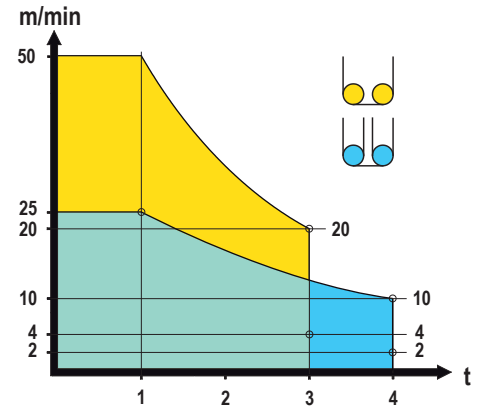

(1) Optional

Montaggio - Erection - Montage - Montage - Montaje

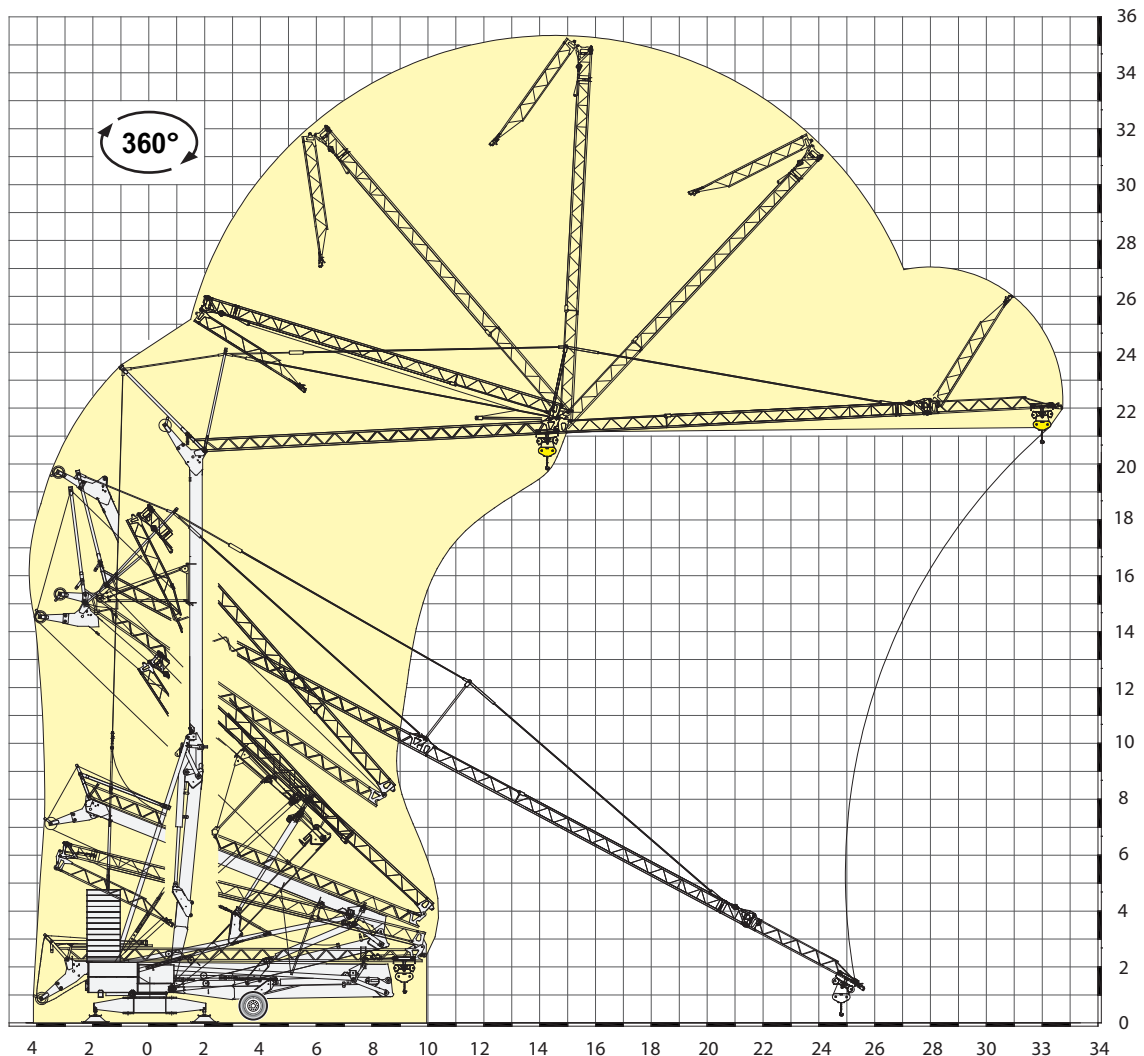

Contrappeso in lastre di cemento armato - Ferro-concrete ballast slabs
Contrepoids en plaques de béton armé - Gegengewicht aus Betonplatten - Lastre en hormigón armado

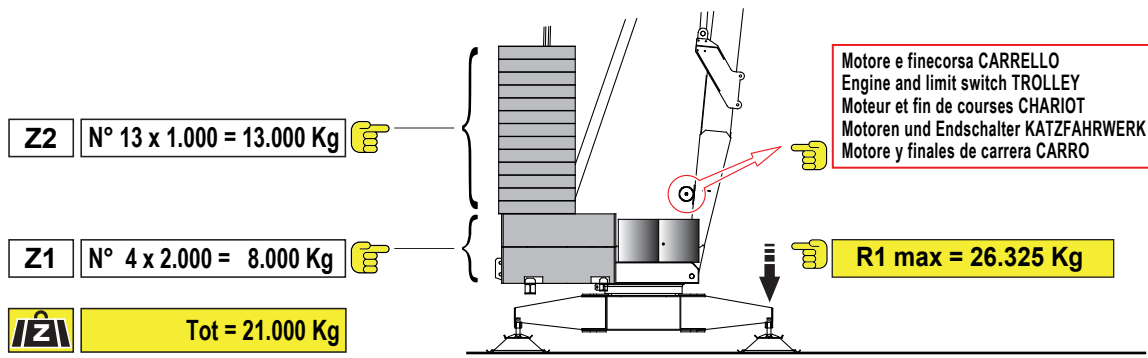

Trasporto - Transport - Transport - Transport - Transporte

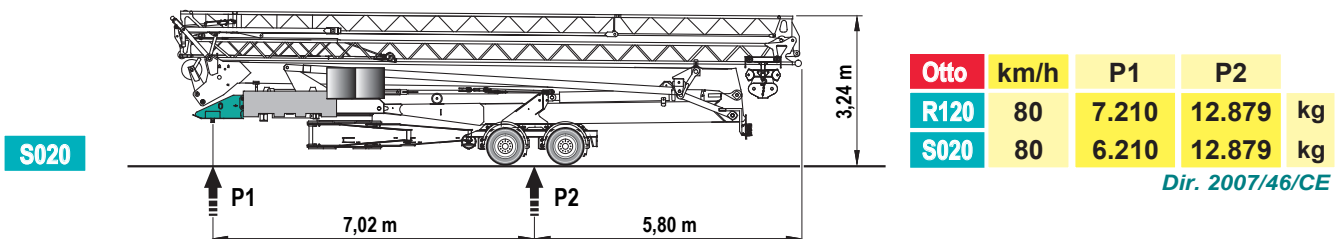
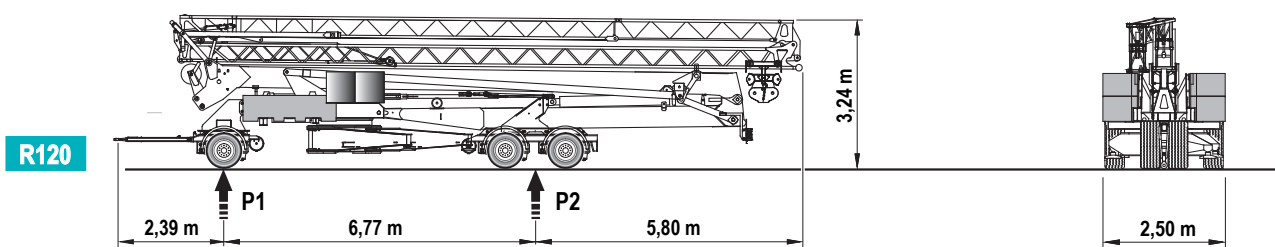
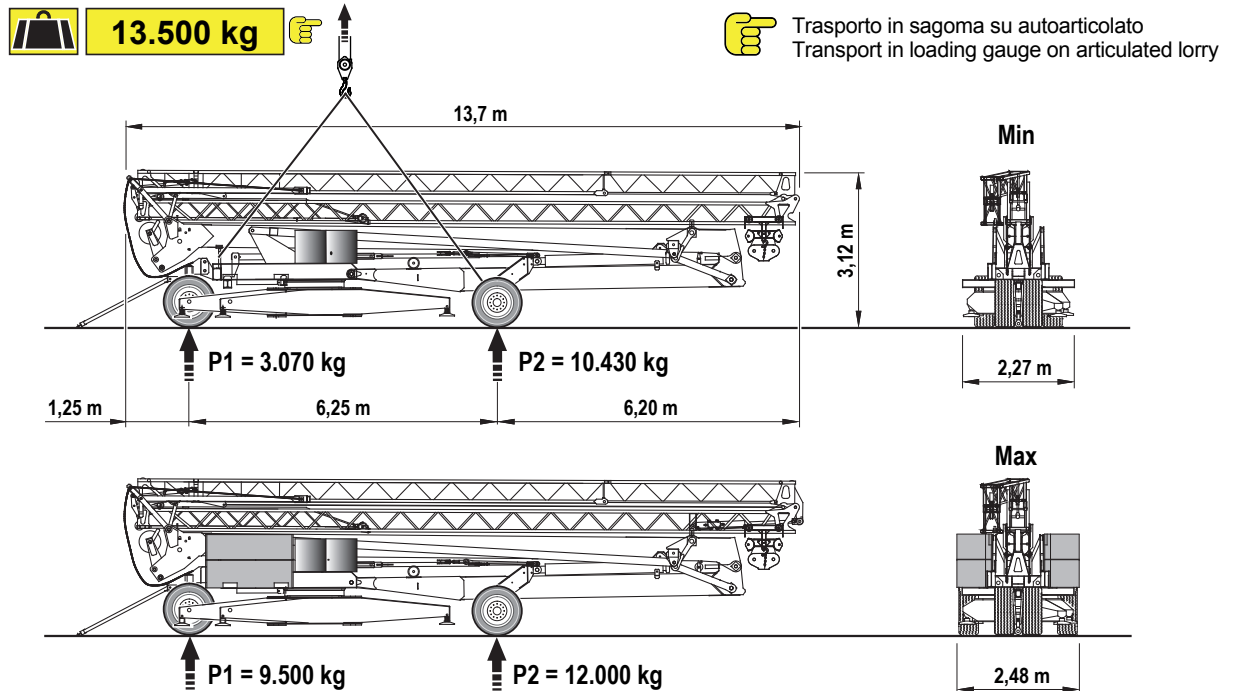

CATTANEO

Luigi Cattaneo S.p.A.

via Trieste, 14 - 20020 Magnago (MI) Italia
 tel. +39 331 657132 - fax +39 331 305460
 www.cattaneogru.it - e-mail: cattgru@tin.it